

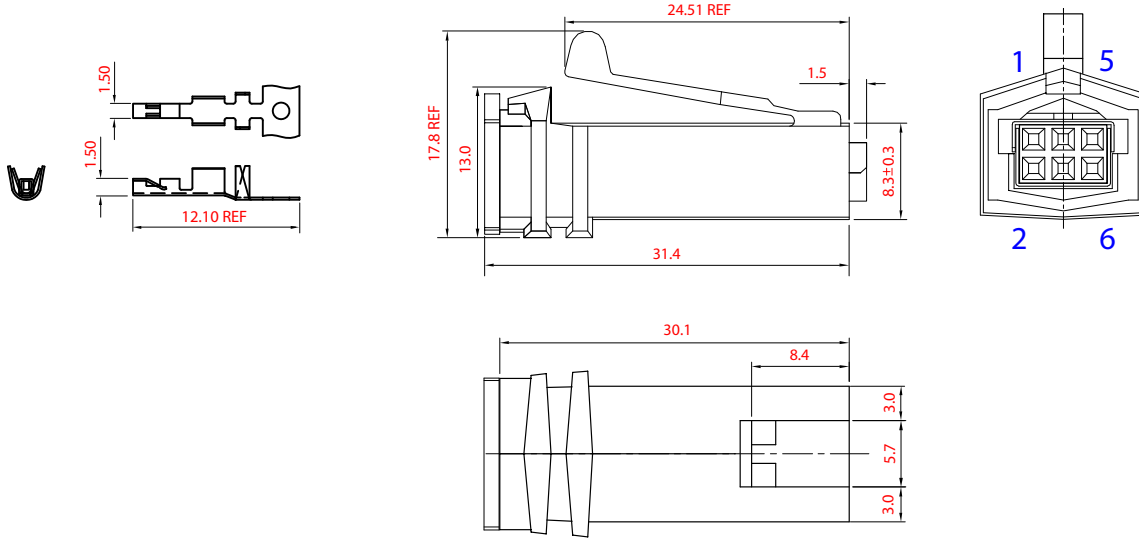

REVISIONS		
REV	DESCRIPTION	DATE
A	RELEASE FOR QUOTE	12/2006



Note:
 1. All materials conform to EN Directive 2002/95/EC for RoHS compliance.
 Electrical Characteristics:
 Contact Resistance: Terminal 25m Max. and ground terminal 8m Max.
 Insulation Resistance: 100M Min. at 500V DC.
 Dielectric Strength: 750V AC/1 minute.
 Insertion Force: 5.9kgf Max.
 Withdrawal Force: 1.59 ~ 5.9 kgf
 Latch Retention: 9.07 kgf Min.

UNLESS OTHERWISE SPEC'D DIM. ARE IN MILLIMETER. TOL. ARE: FRACTION DECIMAL ANGULAR ± .008 ± .004 1/2°		THIRD ANGLE PROJECTION		CONQUEST TECHNOLOGY LIMITED	
MATERIAL		APPROVALS	DATE	6 Pin PoweredUSB, 2x3 Plug Connector with Extended Latch, 6.5mm Exit Hole, Pebble Grey - RoHS	
FINISH		DRAWN Seto	12/20/06	SIZE A	DWG. NO. 371258
DO NOT SCALE DRAWING				SCALE: N/A	SHEET 1 OF 1